

PROFILE

SCALE: HALF

* = WOOD GRAIN TEXTURE

NOTES:

MATERIAL: 5/8" MIRATEC w/ WOOD GRAIN TEXTURED FACE

NOMINAL SIZE: 8"

ACTUAL SIZE: 7 1/4"

EXPOSURE: 5 3/4"

COVERAGE: 4.12 SQ FT

WEIGHT: APPROX 1.5 PSF

FLAME SPREAD: 125

SMOKE DEVELOPED: 120-145

CARB COMPLIANT

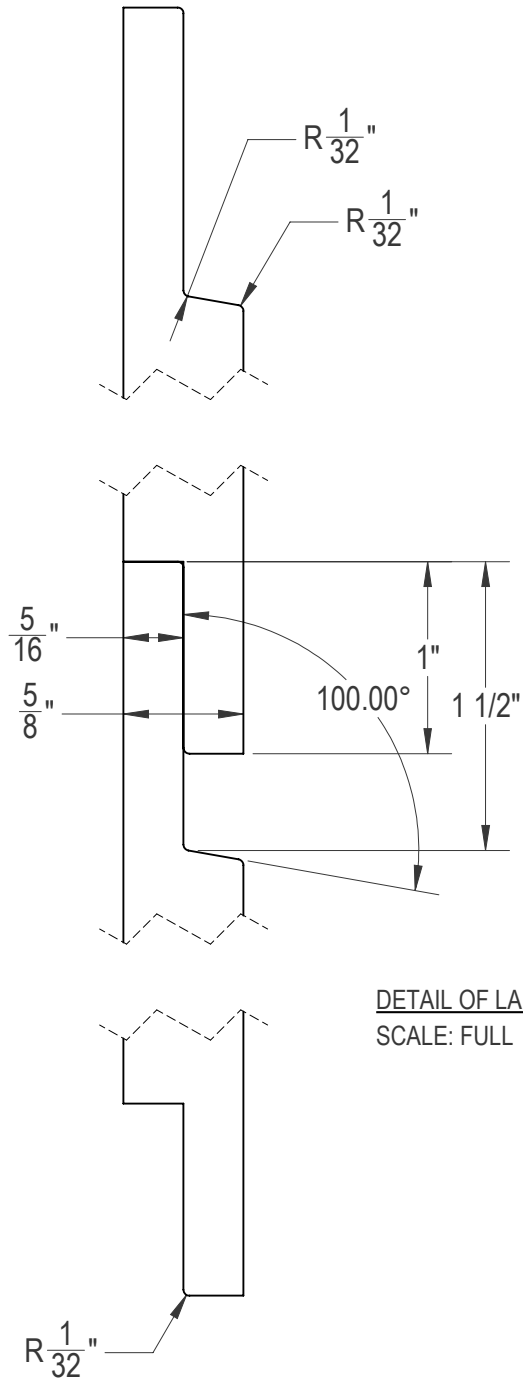

DETAIL OF LAP
SCALE: FULL



IDENTITY WOOD PRODUCTS, LLC
Ball Ground, Ga. 30107
www.identitywoodproducts.com
Ph. 1-800-585-4120

REV	DATE	BY	DESCRIPTION
A	1/06/18	DRD	RELEASE
B	1/18/18	DRD	RELEASE
C	2/20/2018	DRD	CHANGED LOGO HD

DWG. NAME:

8" SHIPLAP
W/ 1/2" GAP

DWG. NO.

M0812-0000

DWN BY: DRD	CHK BY: JFD
----------------	----------------

SCALE: NOTED

DWG. NO:
VW-1006

Reproduction of this document without the written authorization of IDENTITY WOOD PRODUCTS, LLC is strictly prohibited Copyright 2017, IDENTITY WOOD PRODUCTS, LLC.